

**PART NUMBER:** CS-3606

**DESCRIPTION:** solid state buzzer

**SPECIFICATONS**

operating voltage	4 ~ 8 V DC	
current consumption	45 mA max.	at 6 V DC
sound pressure level	75 db min.	at 30 cm/6 V DC
tone	continuous	
operating temperature	-20 ~ +60° C	
storage temperature	-30 ~ +70° C	
weight	9.7 g max.	
RoHS	yes	

**APPEARANCE DRAWING**

tolerance: ±0.5  
units: mm

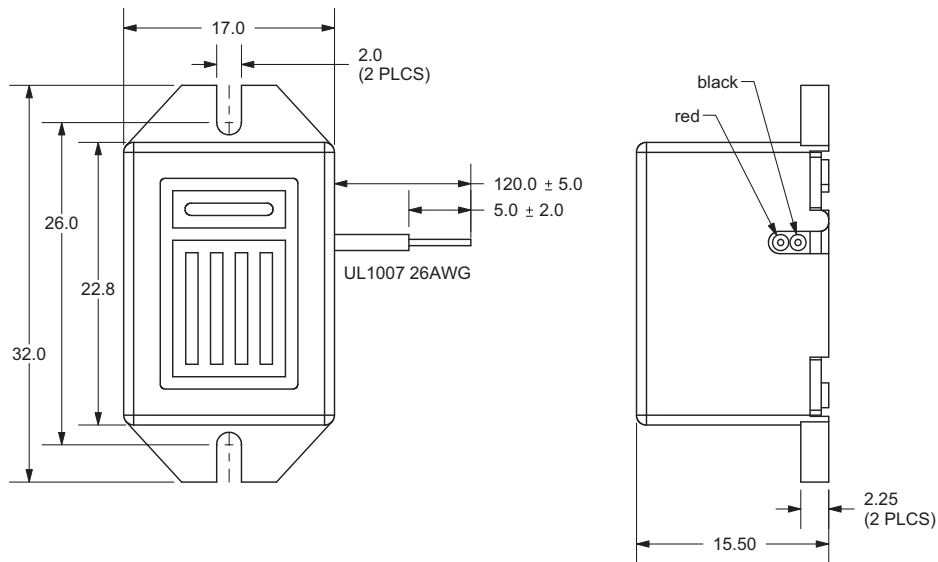

**CURRENT CONSUMPTION/SOUND PRESSURE LEVEL**

